

後身①

B.C.

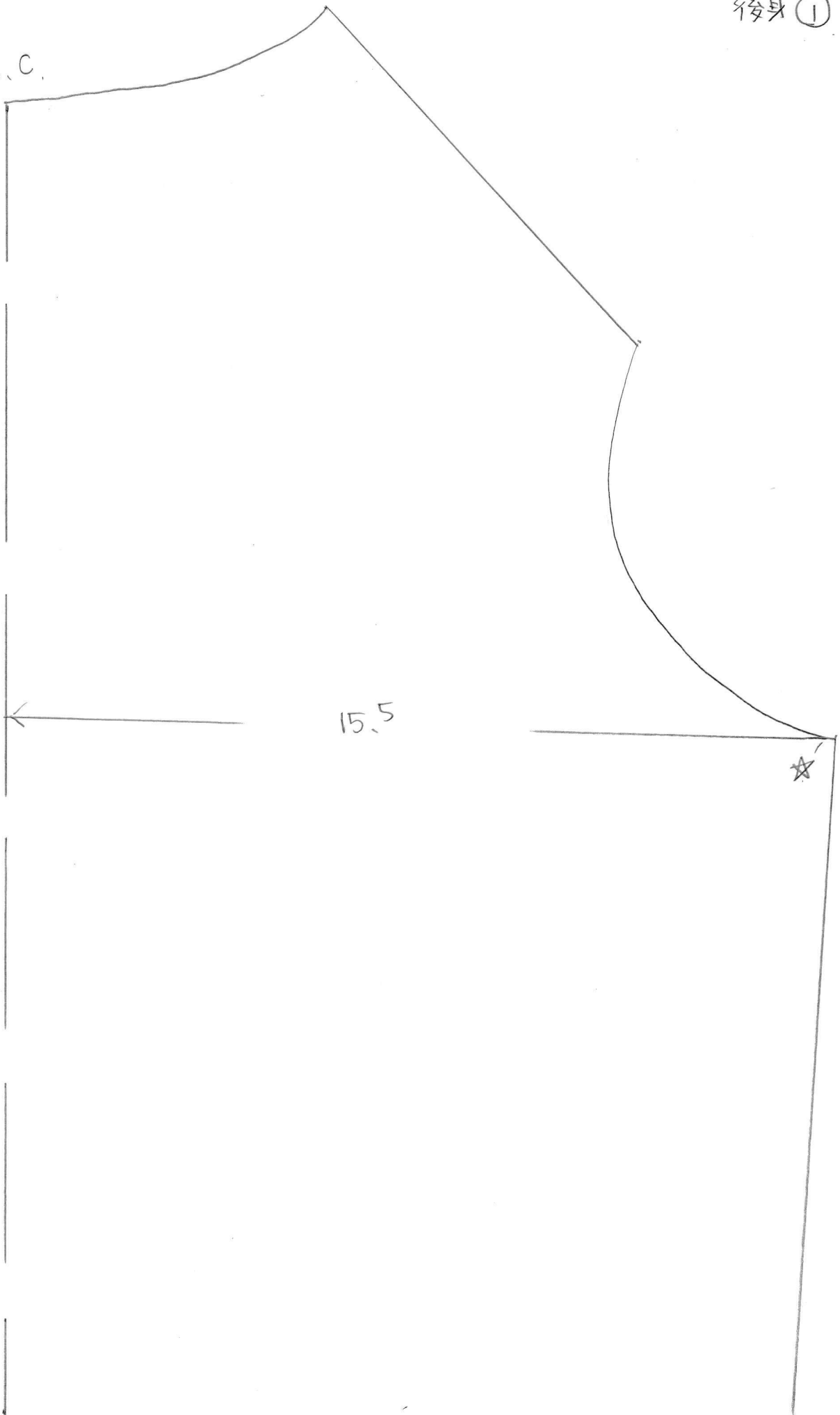

後身(2)

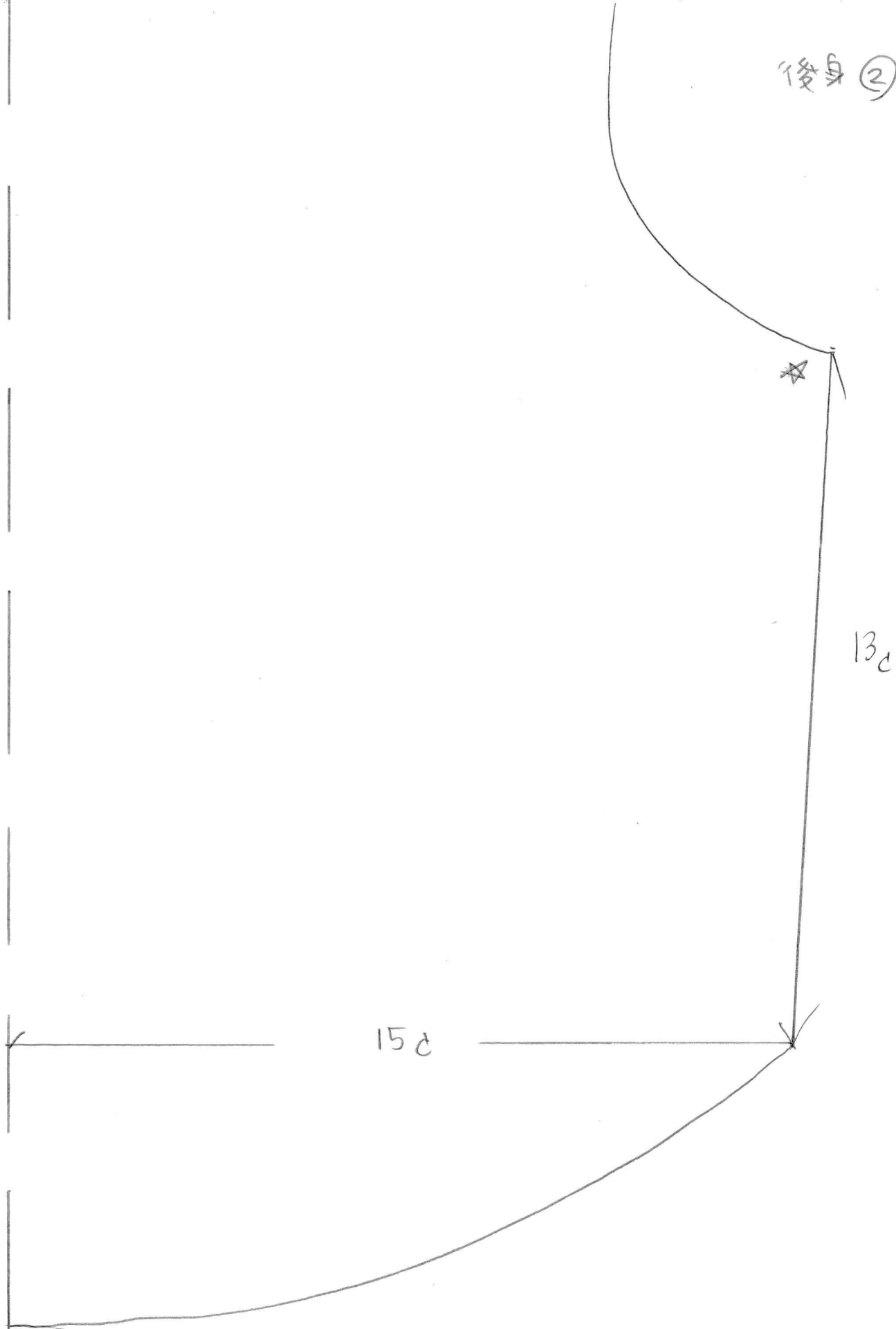

B.C

前身

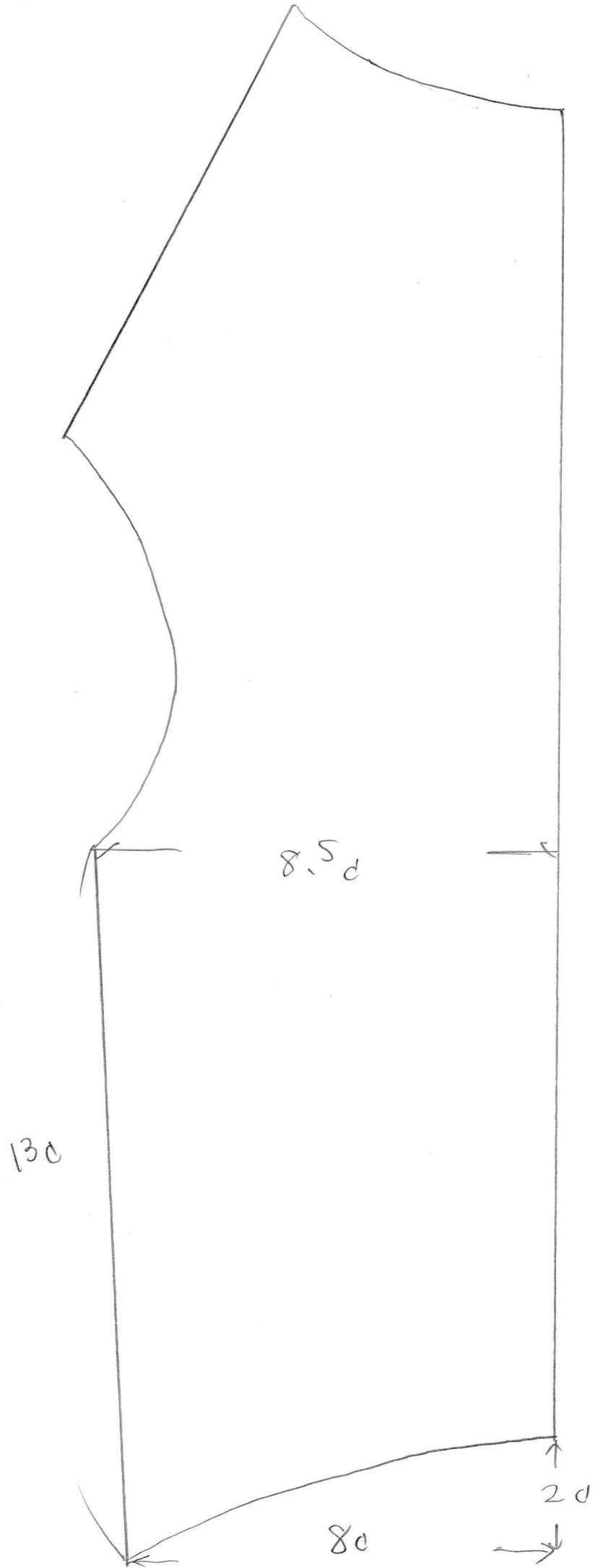

8.5  
9

袖

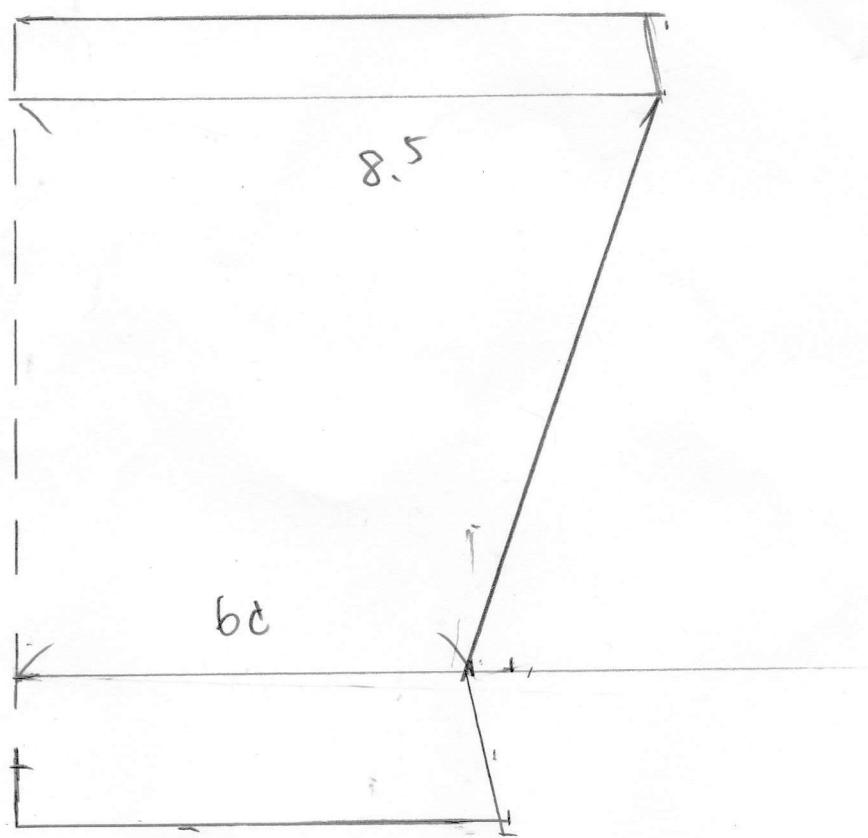
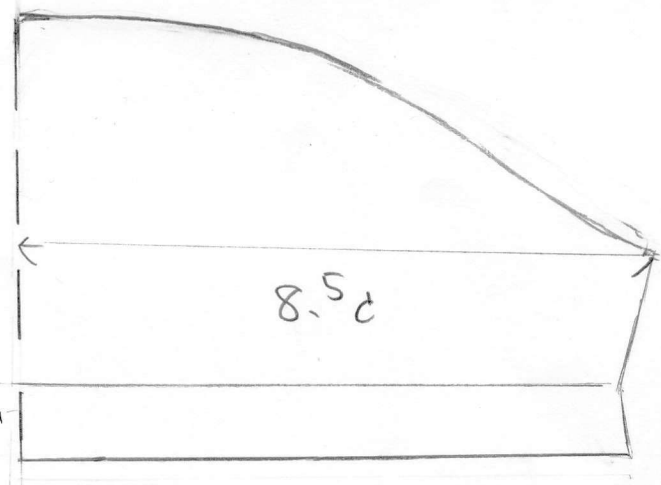

縮R 1/2

後裾

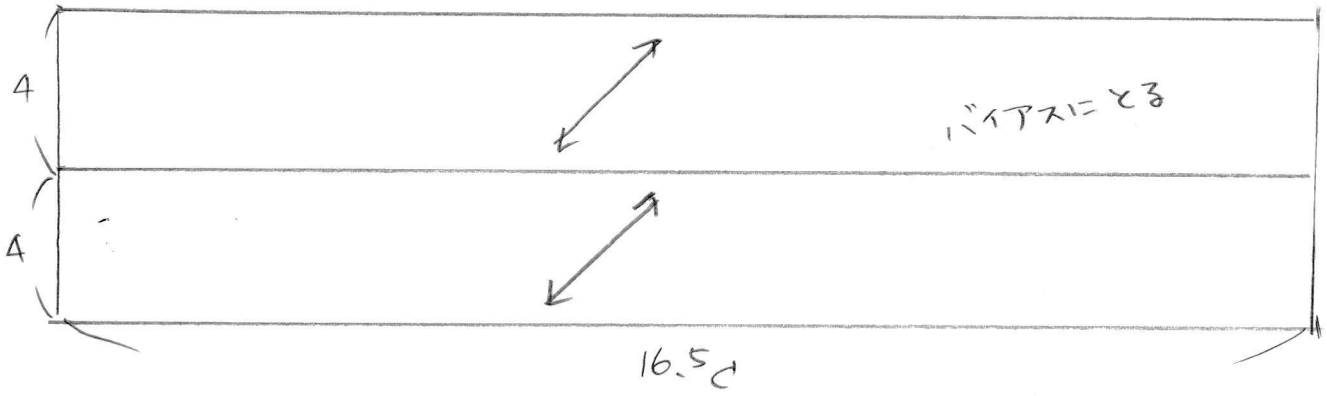

前裾

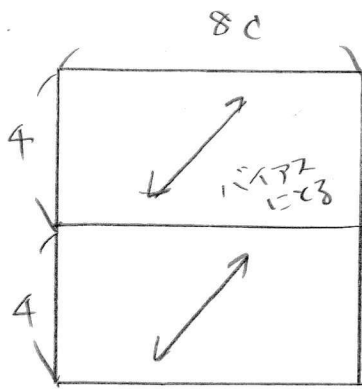

28.5

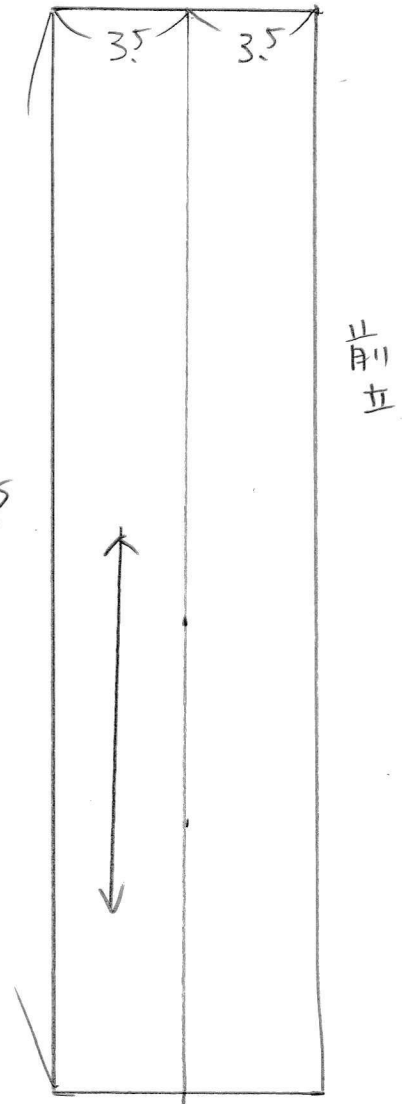

くちばし

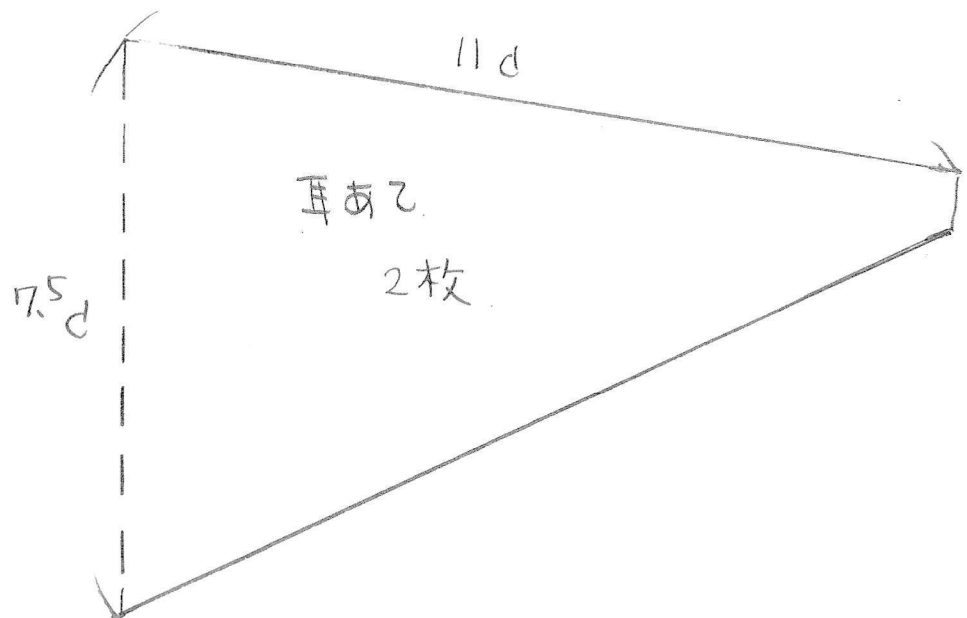
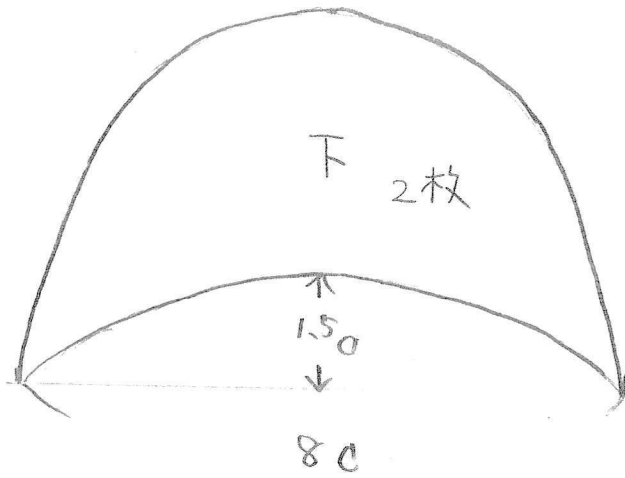
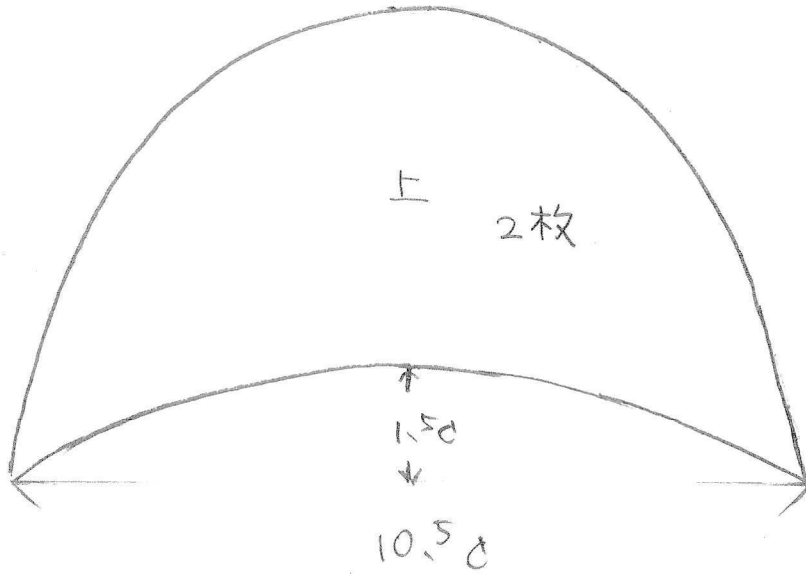

前頭

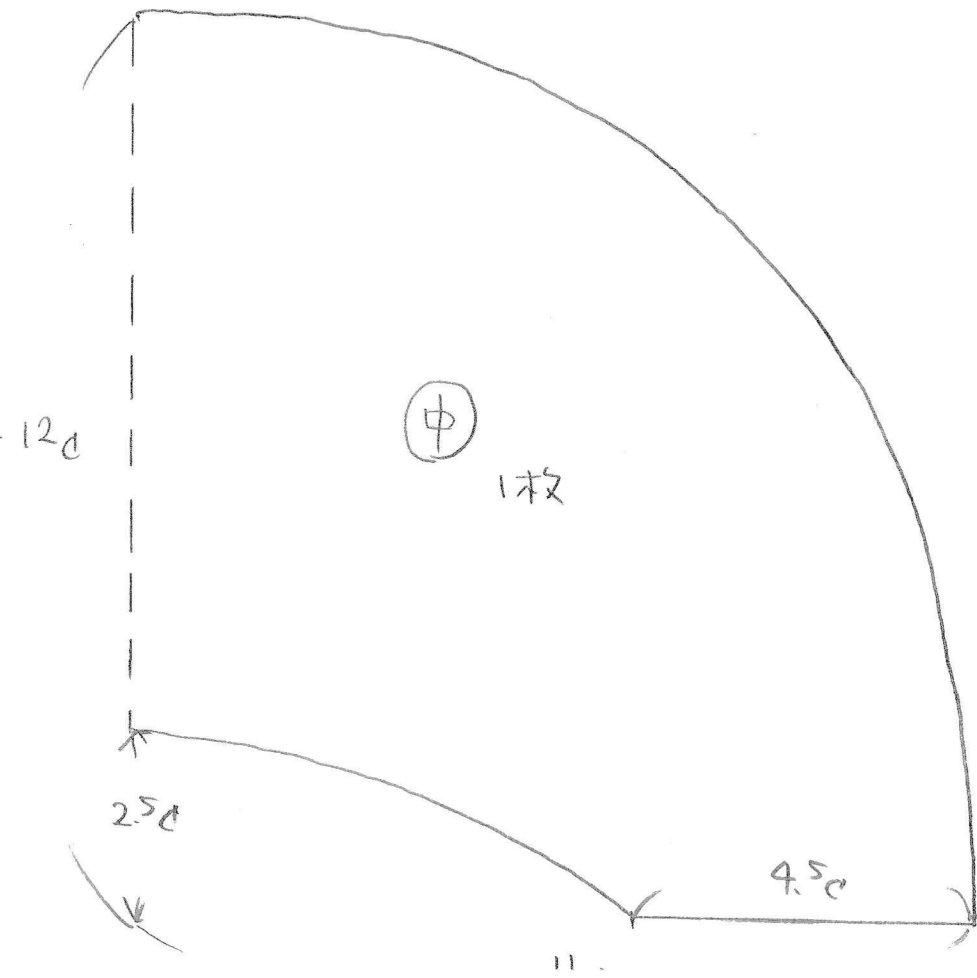
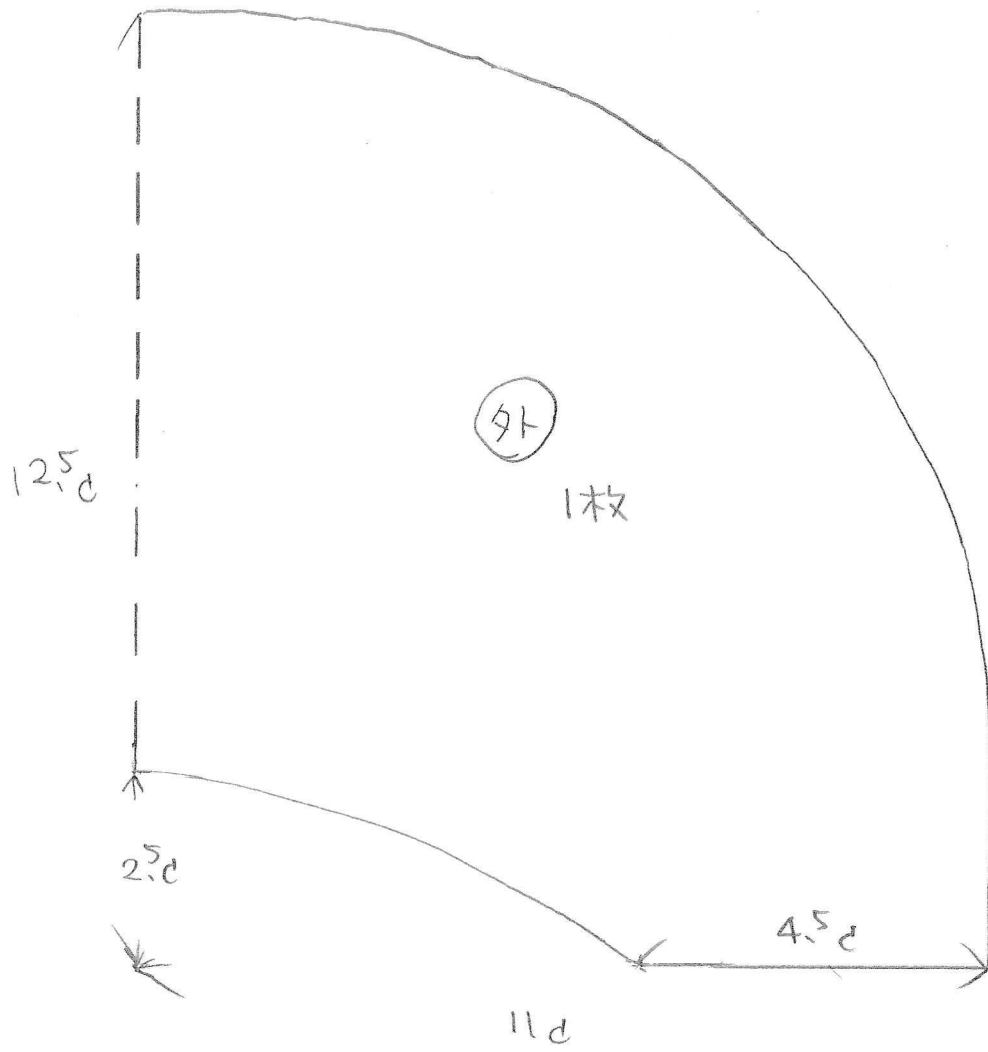

後3頭

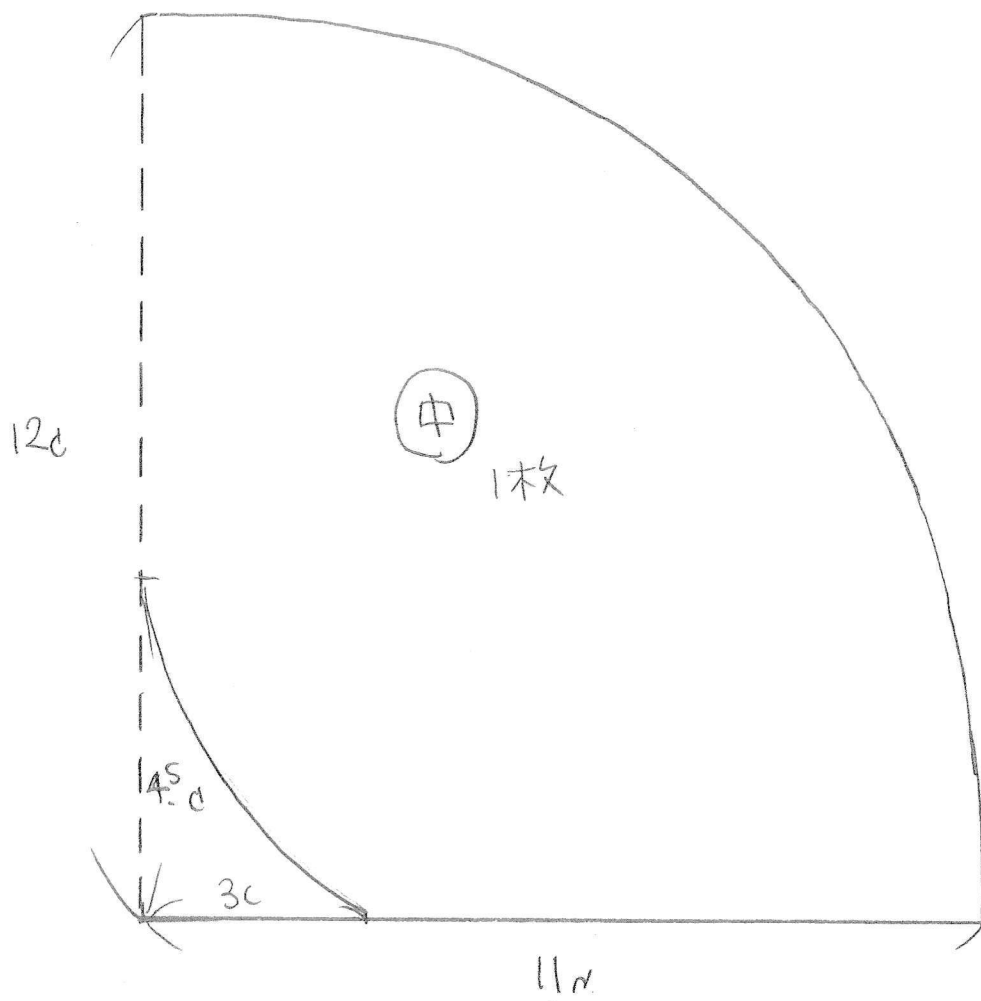
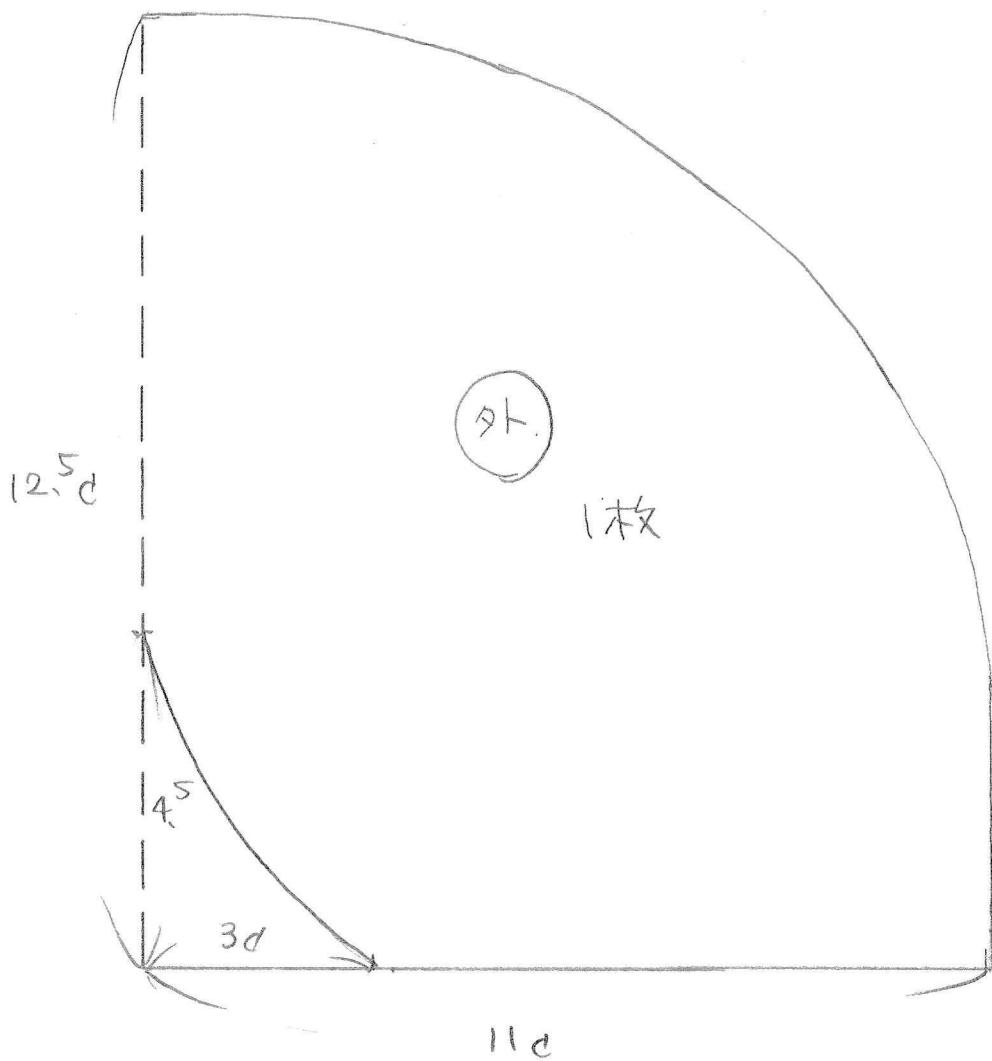



つばさ

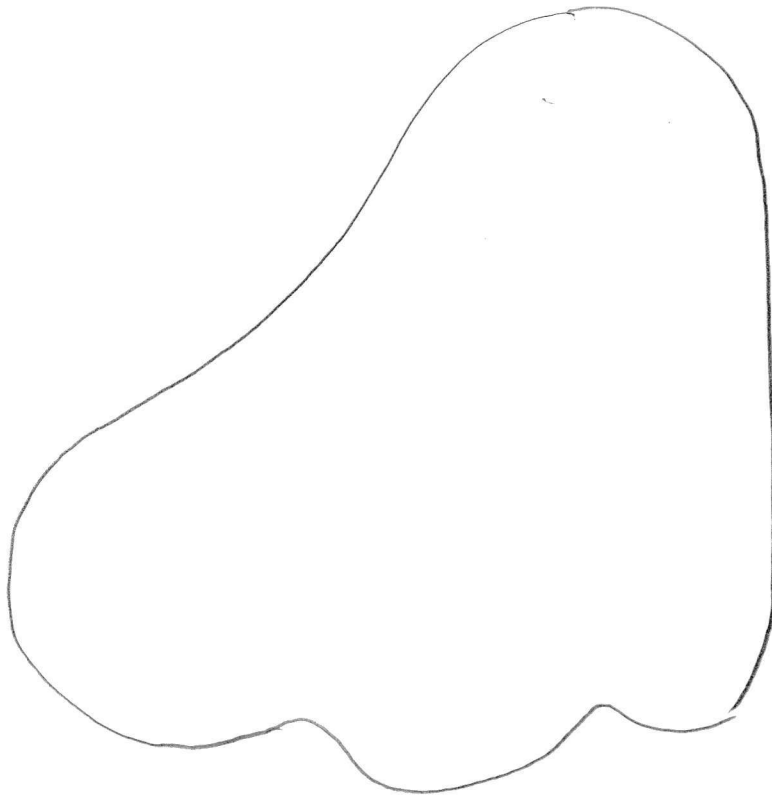

あまり参考に  
なりませんか  
いちおう...

←おめい代  
1cm 足り

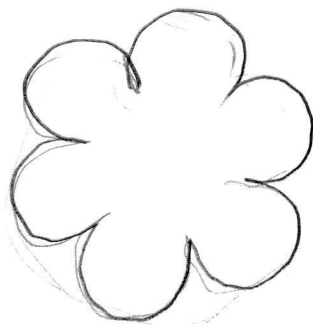

←目につからた  
フェルト

糸通しはしめ.

ここで引き抜く.

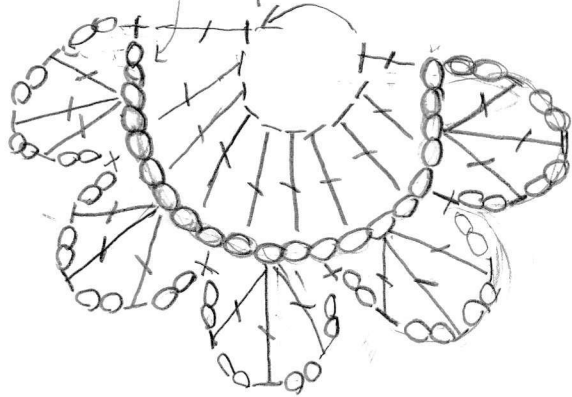

シッポ

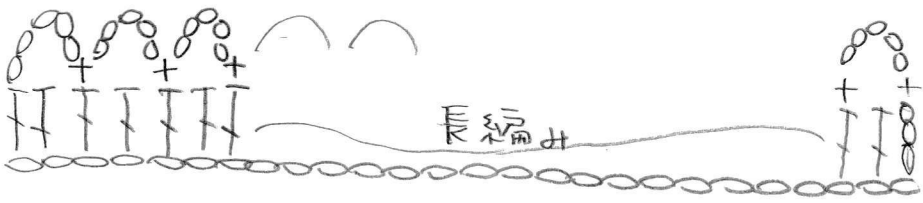

長編み

後裾のフリル

うばせの  
下のふちふち

